

Fabric-Reinforced System Section 07 55 56

Fluid Applied Reinforced Elastomeric Latex Membrane

PART 1 – GENERAL

1.1 Description

- A. Work included: all labor, materials, equipment and accessories to furnish and install fluid applied Rapid Roof® III, Rapid Roof® HV, Equinox®, Benchmark® and PUMA® XL coatings over board-stock roof insulation, roof deck, existing built-up roofing and (*with membrane coating seam treatment*) approved membranes EPDM, PVC, TPO, CSPE, CPA, Modified Bitumen.

(FOR APPROVED MEMBRANES)

PLEASE SEE: INSPECTIONS, PREPARATION AND APPLICATION BELOW.

- B. Related work specified elsewhere:
1. Board-stock roof insulation: section 07220
 2. Sheet metal work
 3. Prefabricated roof specialties
 4. Roof accessor,

1.2 Quality Assurance

- A. Certification of materials: (Applicable for manufacturer's material warranties.) Upon completion of roofing system, photographs are required and an inspection shall be performed by the applicator to ascertain that the roofing system has been installed according to manufacturer's published specifications and details.
- B. Certification of materials: Conklin Company Inc. shall furnish, upon request written, notarized certification that the material furnished meets the physical properties set forth in this specification.
- C. Requirements of regulatory agencies: furnished and install all roofing materials required to meet regulatory specifications and approved building codes. If changes are required to drawings or specification in order to meet requirements of regulatory agencies specified, or to provide guarantee specified, cost of such changes shall be included. Any changes to drawings or specifications shall be approved by the architect before work commences.

1.3 Submittals

- A. Product data: shall include manufacturer's product specifications and installation instructions.
- B. Certified test: Submit copies of certified test reports that indicate compliance with the specified minimum physical properties and performance requirements.

1.4 Product Delivery, Storage and Handling

- A. Delivery of materials:
 - 1. Membrane materials shall be delivered to the job site in Conklin Company's original, unopened containers bearing manufacturer's original label.
 - 2. Related miscellaneous items shall be delivered to job site in new condition, and where applicable, properly labeled.
- B. Storage of materials:
 - 1. Store materials in accordance with manufacturer's recommendations.
 - 2. Store acrylic latex materials at between 40°F and 100°F
- C. Damaged materials: contaminated or damaged materials shall not be used in the installation and shall be removed from site immediately upon discovery.
- D. **SAFETY & FIRST AID**

See product Safety Data Sheets or product container label to review safety information provided.

1.5 Job Conditions

- A. Environmental requirements:
 - 1. General requirements: application of coatings shall not proceed unless environmental conditions are suitable as prescribed by the manufacturer of the material being supplied. Applicator shall be held responsible for contacting manufacturers of applied materials and verifying manufacturer's requirements for environmental conditions
 - 2. Application temperature requirements:
 - a. Ambient: application shall not proceed when ambient temperature is less than 40°F and rising or greater than 100°F.
 - b. Surface: application shall not proceed when surface temperature is than 40°F and rising or greater than 120°F.
 - c. Do not apply at temperatures below 40°F, when temperatures may drop below 40°F within 24 hours, or when the temperature is not at least 5°F above the dew point. Do not apply during inclement weather, when precipitation appears imminent, or when freezing may occur before the membrane is fully cured.
 - d.
 - 3. Equinox application temperature requirements:

- a. Ambient: application shall not proceed when ambient temperature is less than 36°F and rising or greater than 70°F.
 - b. Surface: application shall not proceed when surface temperature is less than 36°F and rising or greater than 90°F.
 - c. Do not apply at temperatures below 36°F, when temperatures may drop below 36°F within 24 hours, or when the temperature is not at least 5°F above the dew point. Do not apply during inclement weather, when precipitation appears imminent, or when freezing may occur before the membrane is fully cured.
- B. Protection of unrelated work: take all measures necessary to protect unrelated work and surfaces to avoid overspray from coatings.

PART 2—PRODUCTS

2.1 Fluid Applied Reinforced Elastomeric Latex Membrane

- A. Acceptable manufacturer: Conklin Company Inc., Shakopee, Minn., Rapid Roof III, Rapid Roof HV, Equinox, Benchmark and PUMA XL.
- B. Description: a seamless membrane system consisting of Rapid Roof III, Rapid Roof HV (only for use on concrete), Equinox or Benchmark fluid applied acrylic latex base coat with fabric embedded into it and fluid applied acrylic latex top coat.
- C. Physical and performance requirements for elastomeric acrylic latex coating system: Rapid Roof III, Rapid Roof HV, Equinox, Benchmark and PUMA XL consisting of an acrylic latex base coat and top coat, when tested with Spunflex polyester fabric using ASTM D412 procedures, will meet the following performance.
- D. Physical and performance requirements of Spunflex:
 - 1. Fabric type: knitted polyester
 - 2. Yarn denier: 70
Construction: 28x30 per square inch
 - 3. Nominal weight: 2.24 ounces per square yard
 - 4. Mullen burst: 80.6 psi
 - 5. Elongation (ASTM 1682)
 - a. MD: 54% MD =Machine Direction
 - b. XD: 147% XD = Cross Direction
 - 6. Grab breaking strength (ASTM 1682)
 - a. MD: 54 lbs.
 - b. XD: 32 lbs.
 - 7. Fabric thickness (FTM-5136): .024 inch

2.2 Miscellaneous Materials

- A. Caulking: White, bronze or gray Kwik Kaulk® acrylic caulking compound or Conklin 360-S urethane sealant as approved by membrane manufacturer.
- B. Primers: Prime Time® as furnished by membrane manufacturer. **Tack Coat™ as furnished by manufacturer for use on aged membranes EPDM, PVC, TPO, CSPE, CPA, Modified Bitumen.**
- C. Roofing granules: No 11 screen size, ceramic coated, color as selected by architect/owner. (optional)

PART 3—EXECUTION

3.1 Inspection

- A. General requirements: inspect roof surface to receive work specified to ensure that the following conditions exist.
 - 1. Roof surface shall be clean, dry, structurally sound and well secured.
 - 2. Roof surface shall be free of ponding water. A roof surface which has 36 or more square feet of water in any area, one-fourth inch deep or more, 48 hours after a rain, shall be considered unacceptable. Small “bird baths” cannot account for more than 5 percent of the entire roof surface.
 - 3. Roof surfaces which are chalky, friable, waxy or oily are not acceptable to receive membrane.
 - 4. Determine moisture content of substrate, insulation and deck. A moisture content of 10 percent by weight or greater, above the normal moisture content of existing materials, indicates a potential problem and work shall not proceed until cause of high moisture content is verified and condition is corrected.
 - 5. Inspect condition of flashing details adjacent to protrusions, curbs, walls, drains and roof edge to ensure that details are acceptable and will maintain a weather tight installation.
- B. Inspection of existing built-up roofing.
 - 1. Built-up roofs which are in excess of two roofs (or a total of eight plies of roofing felts or a flood coat which is greater than one-fourth inch thick) shall be removed.
 - 2. Built-up roof surfaces which are severely alligatored (more than 30 percent), blistered, split, cracked, brittle or exhibiting gravel turnover shall be removed.
 - 3. Graveled built-up roofs are not acceptable for Fabric Reinforced application.
- C. Inspection of metal deck.
 - 1. Metal surfaces (bare metal, steel, galvanized and aluminum) and prefinished (factory applied coating) shall be dry, clean and free of dirt, rust, corrosion and other coatings or conditions which could affect the bond of the roof membrane system.
 - 2. Slope of roof area shall be not less than one-fourth inch per foot. (This is membrane manufacturer’s recommendation.) Acceptable gauge for metal shall be 18–26 gauge.
 - 3. All joining metal sections shall be properly closed and mechanically fastened or welded.
- D. Inspection of Plywood, OSB deck (or equal)
 - 1. Plywood roof decks shall be APA Exterior rated sheathing. These include C-C plugged, B-C and A-C rated plywood 15/32 inch or thicker
 - 2. OSB or Advantech sheathing 7/16 inch or thicker.
 - 3. Old, deteriorated wood must be replaced with new plywood.
 - 4. Plywood panels shall be securely fastened to support members in accordance with APA and building code standards. Resin coated, ring shank or screw type nails are recommended. Ensure that all nail heads are installed flush with surface.
 - 5. Other acceptable insulation board stocks are polyisocyanurate having a minimum thickness of 1.5 inch. Contact the Conklin Company for specific manufacturers and brands of acceptable insulation or recovery boards.

- E. Inspection of concrete deck.
 1. Surface must be high density. Troweled smooth and fully cured.
- F. Inspection of Modified Bitumen and Roll Roofing: System shall be applied only to Modified Bitumen and Roll Roofing which meet the following requirements.
 1. The roof shall have positive drainage in accordance with ICC requirements.
 2. The roof must be securely bonded to substrate (must be fully-adhered or factory-approved mechanically fastened system only.
 3. Contains no cracks, blistering or tunneling.
 4. Granulated Modified Bitumen must not have more than 20% granule loss.
- G. Inspection of "Approved" membrane: System shall be applied only to "Approved" membranes which meet the following requirements.
 1. The roof shall have positive drainage in accordance with ICC requirements.
 2. Roof surface shall be free of ponding water. A roof surface which has 36 or more square feet of water in any area, ¼ inch deep or more, 48 hours after a rain, shall be considered unacceptable. Small "bird baths" cannot account for more than 5% of the entire roof surface.
 3. Contains no blistering or tunneling.
 4. Is securely bonded to substrate (must be fully-adhered or factory-approved mechanically fastened system only –
***BALLASTED MEMBRANES ARE NOT APPROVED FOR APPLICATION)**
 5. Is clean, dry, free of contaminants and capable of accepting acrylic coatings.
 6. Is free of pinholes and voids.
 7. Adhesion tests are required and must be performed as follows:

Roof Size	Required # of tests	Notes
< 5,000 sq. ft.	3	Minimum 2 tests in corners or at parapet walls of roof
5,000 - 20,000	6	Minimum 4 tests in corners or at parapet walls of roof
20,000 - 80,000	10	Minimum 6 tests in corners or at parapet walls of roof
> 80,000	1 per 10,000 sq. ft.	Minimum 60% of all test performed in the field of roof.

3.2 Preparation

- A. Preparation of 20 psi polyisocyanurate ACII or ACIII (or equal)
 1. Polyisocyanurate shall be free of dust, dirt, grease, oil and water prior to application of membrane. Before coating work is commenced, surface shall be inspected and tested as necessary. Thoroughly sweep, blow or vacuum clean all surfaces to be coated. Exposed polyisocyanurate shall be primed with Prime Time Plus® if left exposed overnight.
 2. Polyisocyanurate substrates shall be free of voids, splits and cracks. Multiple layers shall be laid perpendicular to one another to promote off set seams.
 3. Caulk termination points and seams and allow drying.
 4. Embed a four-inch-wide strip of Spunflex or Spunflex II fabric in acrylic latex base coat material applied at a rate of 1.5 gallons per square over center of all joints and flashings. Apply a second coating of acrylic latex base coat material over tape at a rate of .5 gallon per square. Allow the joint area to dry– normally for 24 hours.

- B. Preparation of existing built-up roofs – smooth
 1. Remove blisters and major defects and replace with appropriate material.
 2. Caulk and joint tape cracks, splits and minor defects.
 3. Power wash surface.
 4. Replace deteriorated flashing.
 5. Install four-inch cant strip at vertical surface if none present.
 6. Replace deteriorated cant strips.
 7. Eliminate ponded water conditions
 8. Remove and replace wet insulation.
 9. Apply Prime Time® or Prime Time Plus® acrylic latex primer to surface at rate of .5 to .75 gallons per square.
- C. Preparation of metal deck
 2. Acid etch surface of galvanized metal with a 1:20 solution of Rust Off® cleaner to remove all conditions which will affect bond of roof membrane and follow with a thorough water rinse. Power wash and scrub all other approved surfaces.
 3. Clean rusted areas of rust and prime with Conklin's Encase® rust Inhibiting primer.
 4. Caulk all exposed cracks and seams in metal sections.
 5. Just prior to application, remove all dirt, dust and other contaminants by brushing, vacuuming or power blowing.
- D. Preparation of plywood, OSB deck (or equal)
 1. Plywood shall be free of dust, dirt, grease, oil and water prior to application of membrane. Before coating work is commenced, surface shall be inspected and tested as necessary, including sanding to remove contaminants which may affect bond of coating. Thoroughly sweep, blow or vacuum clean all surfaces to be coated.
 2. Plywood decks shall be free of voids. Offsets should have a one-fourth inch space at plywood joints on sides, and one-eighth inch space at plywood joint ends.
 3. Caulk termination points, cracks, seams and knotholes, and allow drying.
 4. The use of Prime Time or Prime Time Plus primer is optional.
 5. Embed a four-inch-wide strip of Spunflex in acrylic latex base coat material applied at a rate of 1.5 gallons per square over center of all joints and flashings. Apply a second coating of acrylic latex base coat material over tape at a rate of .5 gallon per square. Allow the joint area to dry—normally 24 hours.
- E. Preparation of concrete
 1. All cracks exceeding one-sixteenth inch wide shall be either grouted and struck smooth or caulked.
 2. Concrete surfaces shall be cleaned of all oil, grease and dirt. Just prior to application, remove all dust, dirt and other contaminants by brushing, vacuuming or power blowing.
 3. Repair spalled concrete.
 4. Acid etch efflorescing concrete.
 5. Install four inch cant strips at vertical surfaces if none exist.
 6. Replace existing deteriorated cant strips.
 7. Joints and cracks shall be filled with Kwik Kaulk and covered with Spunflex.
 8. After caulk has dried, apply Rapid Roof III, Rapid Roof HV, Equinox, or Benchmark base coat at a rate of 1.5 gallons per square to an area at least four inches on either side of caulking. Embed a four-inch-wide strip of polyester tape into Rapid Roof III, Rapid Roof HV, Equinox or Benchmark

- base coat material. Center Spunflex over joint or crack. Apply a second coating of acrylic latex base coat at a rate of .5 gallon per square.
9. Prime concrete with Prime Time® at a rate of one gallon per square (optional).
- F. Preparation of Modified Bitumen and Roll Roofing
1. Clean surface with Conklin's WAC II so it is free of all contaminants that could affect the bond of Conklin's base coat or primer to the existing roof system.
 2. Caulk termination points, cracks and any gaps 1/8" or larger and allow drying.
 3. Prime with Prime Time® or Prime Time Plus® at a rate of one gallon per square.
 4. For Modified Bitumen and Roll Roofing seams: Apply a 6-inch wide strip of Rapid Roof III, Equinox or Benchmark base coat at a rate of 1.5 gallons per square and immediately imbed the 4-inch wide Spunflex or Spunflex II polyester fabric into the wet coating with a brush or roller, making sure the fabric is relaxed, flat and wrinkle-free by brushing or rolling from the center out at 45° angles.
 5. After the application of coating and fabric, immediately apply a second coat of Rapid Roof III, Equinox or Benchmark base coat at a rate 0.5 gallons per square, for a total 2.0 gallons per square (coating, fabric, coating).
Granulated Modified Bitumen and Roll Roofing have more surface area and for this reason, the above application rates will need to be increased and will vary depending on the surface!
- G. Preparation of approved aged membranes
1. Clean surface with Conklin's WAC II so it is free of all contaminants that could affect the bond of Conklin's Tack Coat to the existing approved membrane.
 2. For "Approved" membrane seams: Apply a 6-inch wide strip of Rapid Roof III or Equinox or Benchmark base coat at a rate of 1.5 gallons per and immediately imbed the 4-inch wide Spunflex or Spunflex II polyester fabric into the wet coating with a brush or roller, making sure the fabric is relaxed, flat and wrinkle-free by brushing or rolling from the center out at 45° angles.
 3. After the application of coating and fabric, immediately apply a second coat of Rapid Roof III, Equinox or Benchmark base coat at a rate 0.5 gallons per square, for a total 2.0 gallons per square (coating, fabric, coating).

3.3 Application

- A. Application method: both membrane base coat and top coat shall be applied by airless spray or 3/4 inch to 1 1/4 inch nap roller.
- B. Application procedure
 1. Develop a systematic method for application of coating to surface.
 2. After seam treatment, apply a three and one-half foot wide strip of Rapid Roof III, Rapid Roof HV, Equinox or Benchmark base coat at a rate of 1.5 gallons per square (Equinox base coat at 1.1 gallons per square) and immediately embed the 38-inch-wide Spunflex or Spunflex II fabric into the wet coating with a brush or roller, making sure the fabric is flat and wrinkle-free by brushing or rolling from center out at 45 degree angles.
 3. After the application of base coat and fabric, apply a second coat of Rapid Roof III, Rapid Roof HV, Equinox or Benchmark base coat at a rate of 0.5 gallon per square, for a total of 2.0 gallons per square.(1.6 gallons per square for Equinox)
 4. After the base coat applications have dried completely, apply a coat of Rapid Roof III, Rapid Roof HV, Equinox, Benchmark, or PUMA XL top coat at a rate of 1.9* gallons per square (Equinox top coat at a rate of 1.6 gallons per square).
 5. The next length of fabric that is installed should overlap the previously

applied fabric by at least two inches.

6. Total rate: the total application rate with Spunflex fabric embedded, plus top coat shall equal a minimum of 38 dry mils at 3.9* gallons per square using Rapid Roof III, Rapid Roof HV, Benchmark, and PUMA XL base and top coats with Equinox base and top coats the total application rate shall equal a minimum of 38 dry mils at 3.0 gallons per square

**To achieve minimum requirements, the application rates listed include 15 percent for application loss and 10 percent to compensate for surface texture.*

Membrane coating specifications must be completed before applying a fabric-reinforced system on an approved membrane!

3.301 Application on approved aged membrane

- A. Application method: base coat and top coat shall be applied by airless spray, brush or ¾" to 1¼" nap roller.
- B. Application rate Procedures:
 1. Apply WAC II cleaner, at full strength, to the "Approved" membrane at a rate of 400-500 square feet per gallon using portable or airless spray equipment equipped with a .019 to .022 spray tip.
 2. Allow cleaner to remain on roof surface at least 20 minutes prior to water rinse, i.e. with high-pressure spray. Heavily soiled areas or loose granules may require additional cleaning and/or use of a floor broom or stiff-bristled brush. Waste or rinse water may be harmful to fish and aquatic plants. Dispose of in accordance with local, state and federal regulations.
 3. Make sure to remove all residues and let roof surface dry thoroughly prior to application of primer.
 4. In situations where the "Approved" membrane has pulled away from or has "bridged" transition areas, such as parapet walls and protrusions, cut the membrane so that it can lie in a relaxed state. Mechanically fasten the cut edge of the "Approved" membrane with Conklin-approved fasteners and 3-inch plates. In the areas where the shrunken membrane no longer covers the roof surface, determine that the substrate is acceptable for application of Conklin fabric reinforced system. If not, make necessary corrections to Conklin-approved substrate. Then, reinforce those areas using Conklin Spunflex fabric and acrylic coatings. (See fabric procedure for "Approved" membrane seams.)
 5. Apply Conklin Tack Coat primer at a rate of 250-300 square feet per gallon with a brush, roller, or spray equipment. The primer will appear an opaque, light gray color upon application and will dry to a glossy black appearance. (Do NOT proceed until primer is completely dry and has a glossy black appearance.)
 6. Primer dry time is approximately 2-8 hours depending on temperature and humidity.
 7. For "Approved" membrane seams: Apply a 6-inch wide strip of Rapid Roof III or Equinox or Benchmark base coat at a rate of 1.5 gallons per and immediately imbed the 4-inch wide Spunflex or Spunflex II polyester fabric into the wet coating with a brush or roller, making sure the fabric is relaxed, flat and wrinkle-free by brushing or rolling from the center out at 45° angles.
 8. After the application of coating and fabric, immediately apply a second coat of Rapid Roof III, Equinox or Benchmark base coat at a rate 0.5 gallons per square, for a total 2.0 gallons per square (coating, fabric, coating).
 9. Apply a three and one-half foot wide strip of Rapid Roof III, Equinox, or

- Benchmark base coat at a rate of 1.5 gallons per square (Equinox base coat at 1.1 gallons per square) and immediately embed the 38-inch-wide Spunflex fabric into the wet coating with a brush or roller, making sure the fabric is flat and wrinkle-free by brushing or rolling from center out at 45 degree angles.
10. After the application of base coat and fabric, apply a second coat of Rapid Roof III, Equinox, or Benchmark base coat at a rate of 0.5 gallon per square, for a total of 2.0 gallons per square.(1.6 gallons per square for Equinox)
 11. After the coating and fabric application has dried completely, apply Rapid Roof III, Equinox (at 1.6 gallons per square), Benchmark, or PUMA XL Top Coat over the entire field of the roof at a rate of 1.9 gallons per square. The top coat dry mil thickness must be no less than 12 dry mils.
 12. Develop a systematic method for application of coating to surface.
 13. Allow each application to dry thoroughly prior to addition applications. Do not allow less than 12 hours drying time between coats, unless otherwise specified.
 14. Do not apply coating in excess of 2.0 gallons per square per coat.
 15. Back rolling top coat is optional after applications by airless spray.
 16. *To achieve minimum requirement, the application rates listed include 15% for application loss and 10% to compensate for surface texture.
- C. Service Walkways: Where service walkways are indicated on the drawings, allow for the following additional work:
1. Walkways shall be constructed following complete drying of roof membrane system.
 2. Mark off area for walkways and apply an additional 1.5 gallon per sq. of base coat. Embed 38-inch Spunflex or Spunflex II fabric and immediately apply an additional coat of base coat at a rate of .5 gallons per square, then back roll and allow coating to dry.
 3. Apply top coat at 1.9 gallons per square and allow drying completely.
 4. Rapid Roof III colored top coat or base coat can be used to designate the walkway as a different color.
 5. For addition protection or better traction: Apply additional top coat at a minimum of 1 gallon per square, and while still wet, broadcast roofing granules on the surface at a rate of 40 to 50 pounds per square.
 6. Spaghetti walkways are also available through Conklin Company Inc. for use in these traffic areas.



END OF SECTION
00004072017

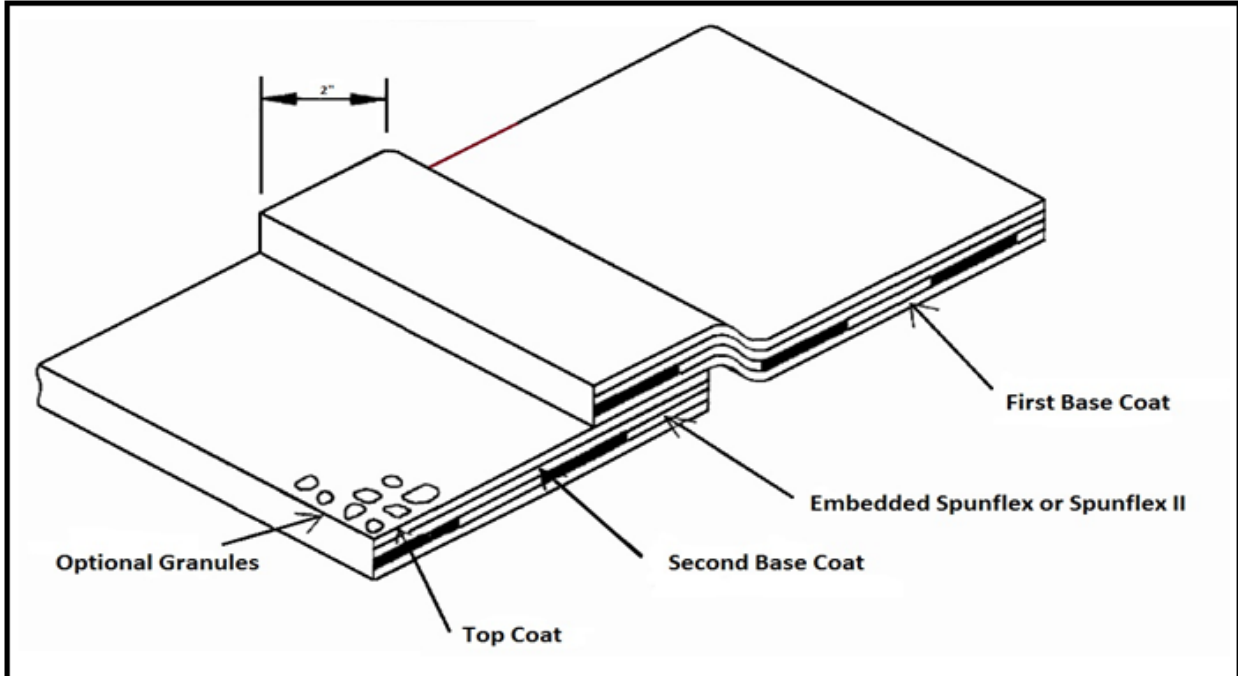

	Fabric Reinforced Application Detail		ISSUE / REVISION Date: 2/14/2017	Detail Number. FRS - 2
	Fabric Reinforced System	Acceptable Products Rapid Roof HV Rapid Roof III, Equinox, Benchmark, PUMA XL	NOT TO SCALE	

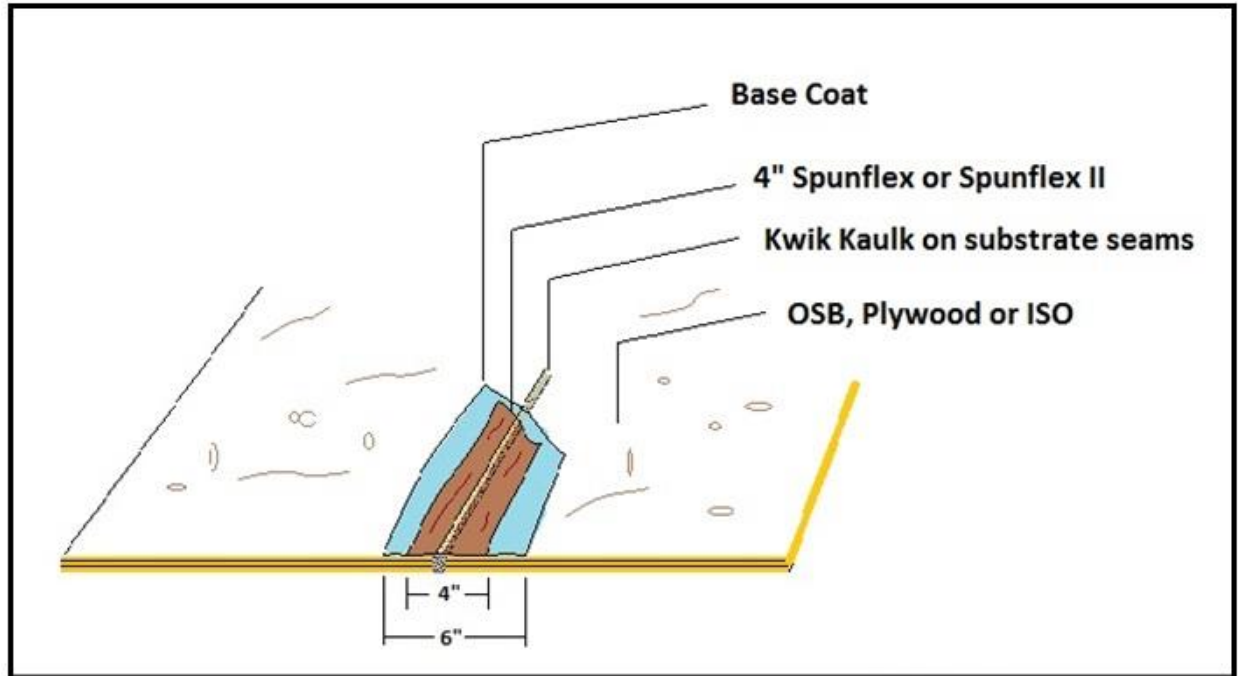

	Fabric Reinforced Caulked Seam		ISSUE / REVISION Date: 2/14/2017	Detail Number. FRCS - 1
	Fabric Reinforced System	Acceptable Products Rapid Roof HV Rapid Roof III, Equinox, Benchmark, PUMA XL	NOT TO SCALE	

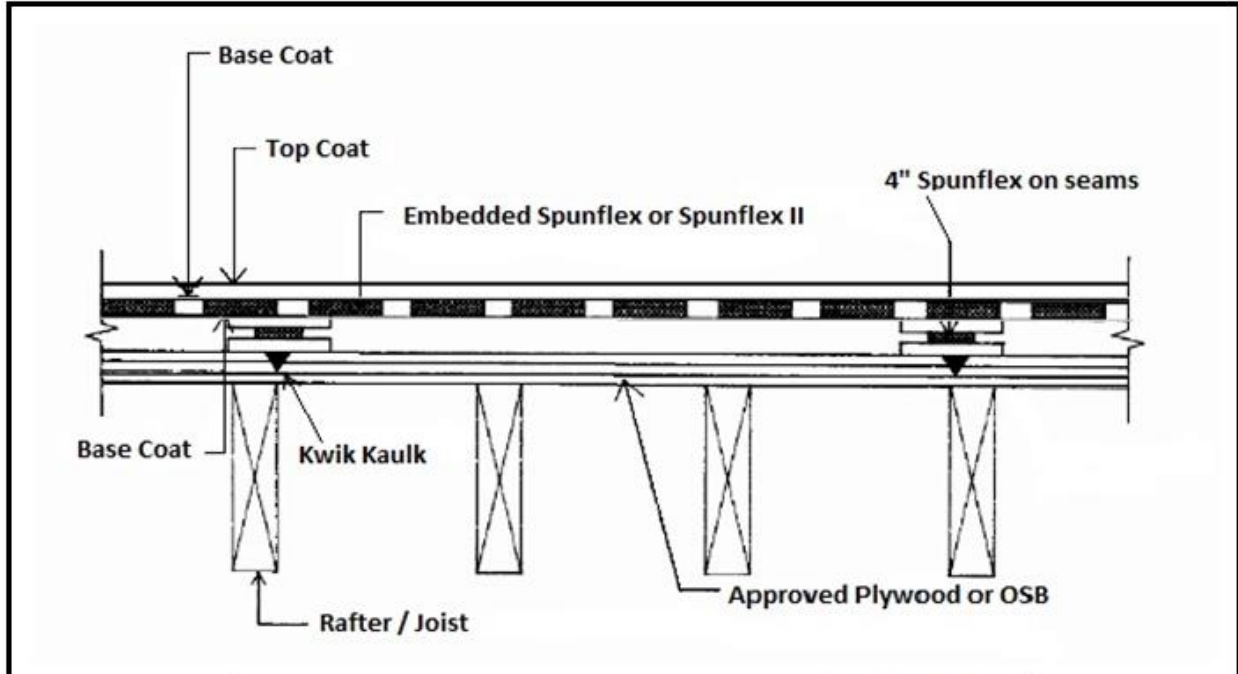

	Plywood Joint Detail		ISSUE / REVISION Date: 2/14/2017	Detail Number. PJD - 1
	Fabric Reinforced System	Acceptable Products Rapid Roof HV Rapid Roof III, Equinox, Benchmark, PUMA XL	NOT TO SCALE	

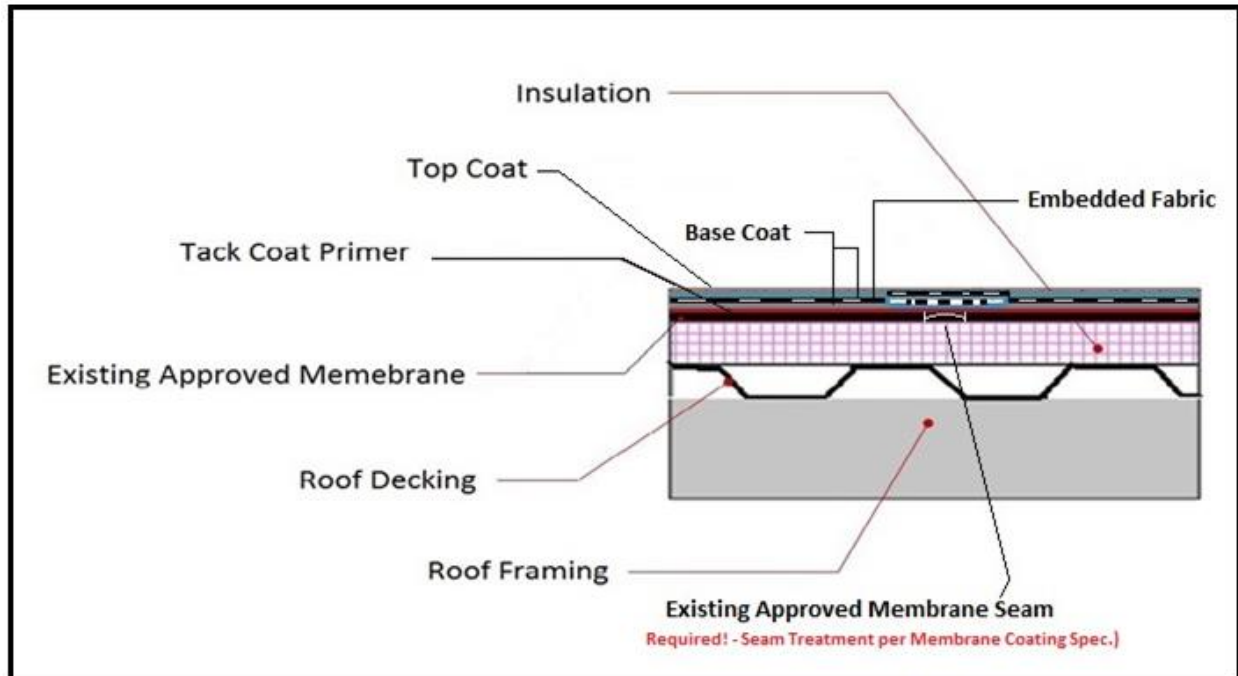

	Fabric Reinforced Membrane Coating		ISSUE / REVISION Date: 2/23/2017	Detail Number. FRMC - 10
	Fabric Reinforced System	Acceptable Products Tack Coat, Rapid Roof HV Rapid Roof III, Equinox, Benchmark, PUMA XL	NOT TO SCALE	

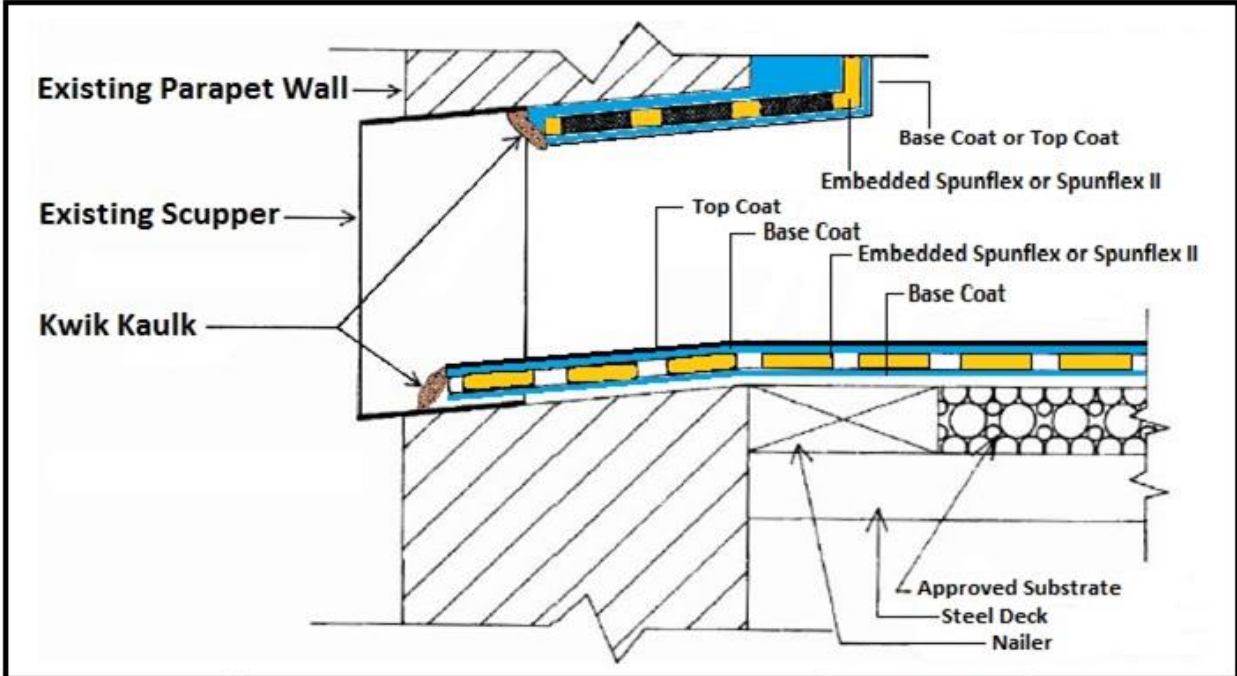

	Fabric Reinforced Scupper Detail		ISSUE / REVISION Date:	Detail Number.
	Fabric Reinforced System	Acceptable Products Rapid Roof HV Rapid Roof III, Equinox, Benchmark, PUMA XL	2/15/2017	SC - 10
			NOT TO SCALE	

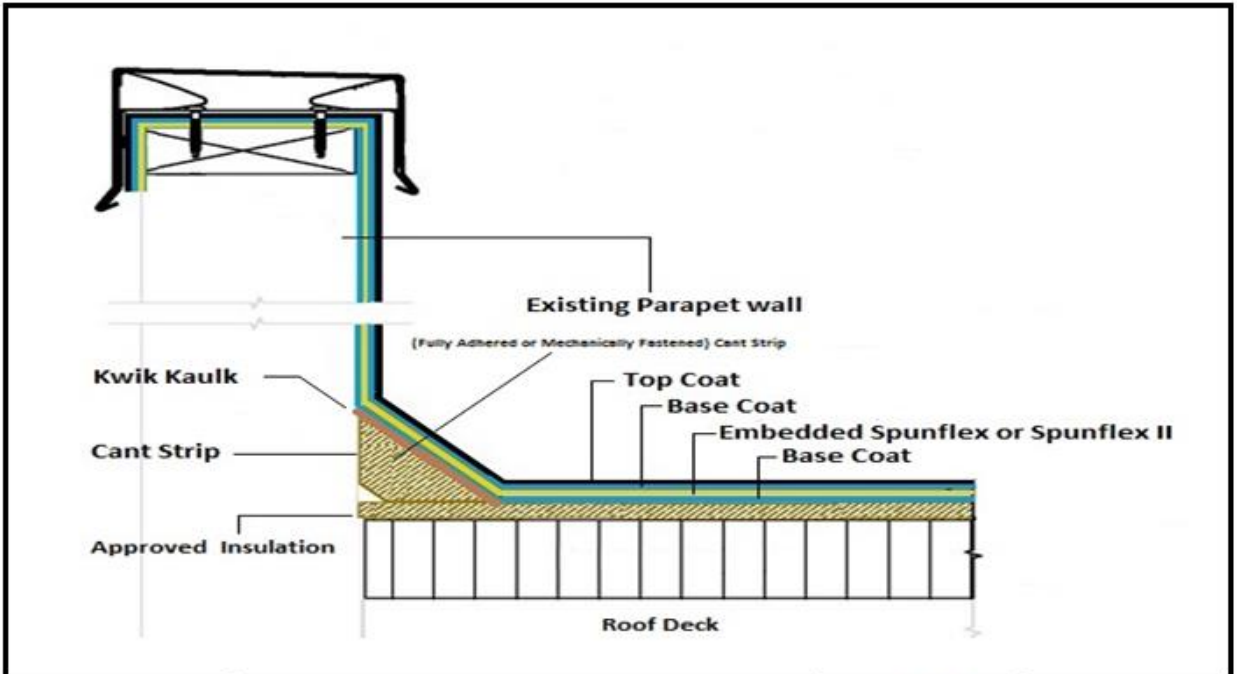

	Fabric Reinforced Parapet Wall		ISSUE / REVISION Date:	Detail Number.
	Fabric Reinforced System	Acceptable Products Rapid Roof HV Rapid Roof III, Equinox, Benchmark, PUMA XL	2/16/2017	PW - 11
			NOT TO SCALE	

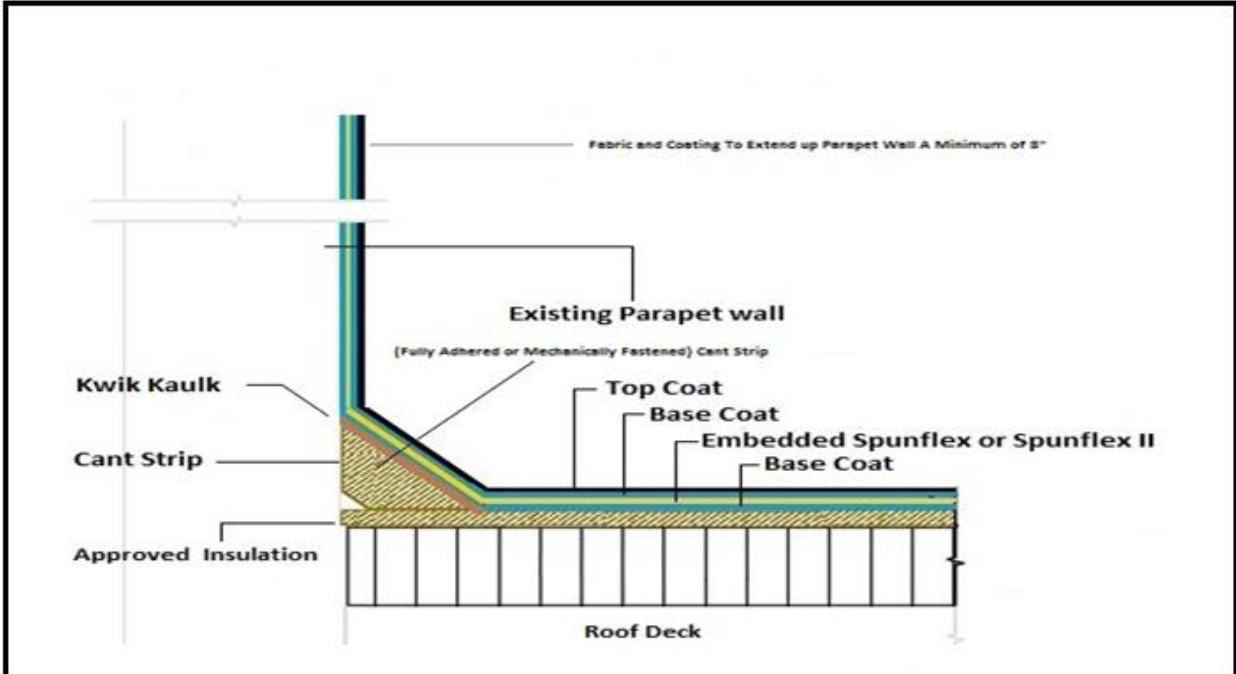

	Fabric Reinforced Parapet Wall		ISSUE / REVISION Date:	Detail Number.
	Fabric Reinforced System	Acceptable Products Rapid Roof HV Rapid Roof III, Equinox, Benchmark, PUMA XL	2/21/2017	PW - 1
			NOT TO SCALE	

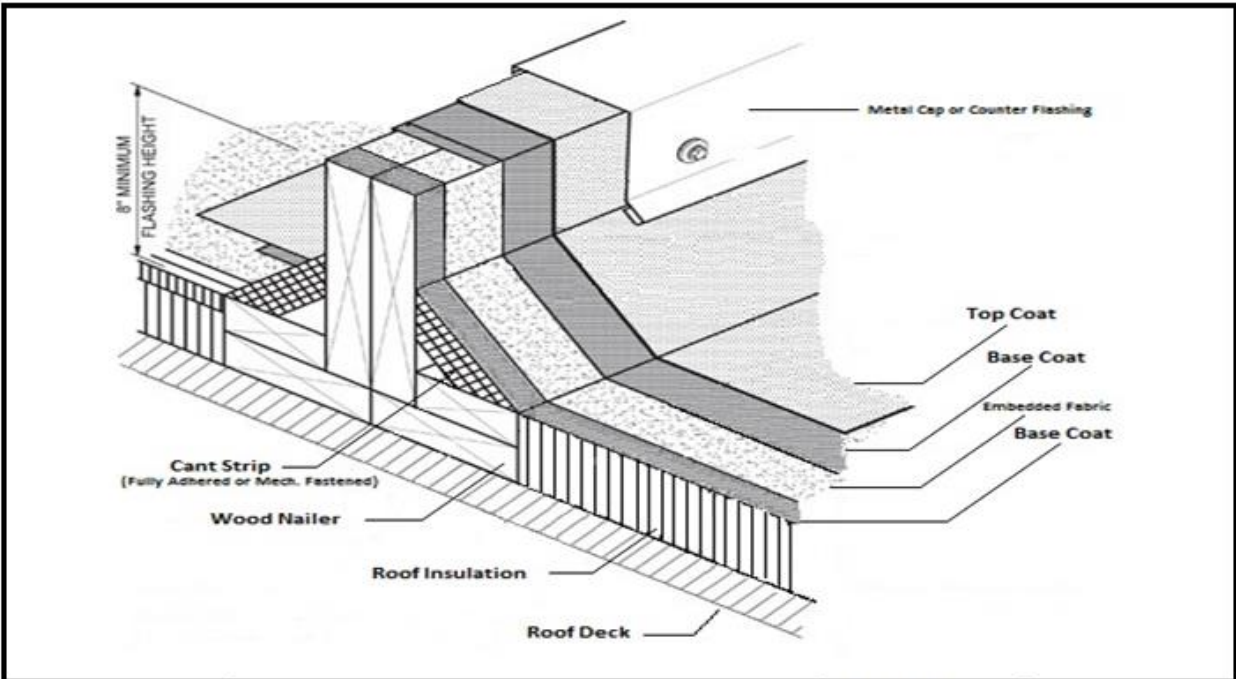

	Fabric Reinforced Curb Detail		ISSUE / REVISION Date:	Detail Number.
	Fabric Reinforced System	Acceptable Products Rapid Roof HV Rapid Roof III, Equinox, Benchmark, PUMA XL	2/21/2017	C - 1
			NOT TO SCALE	

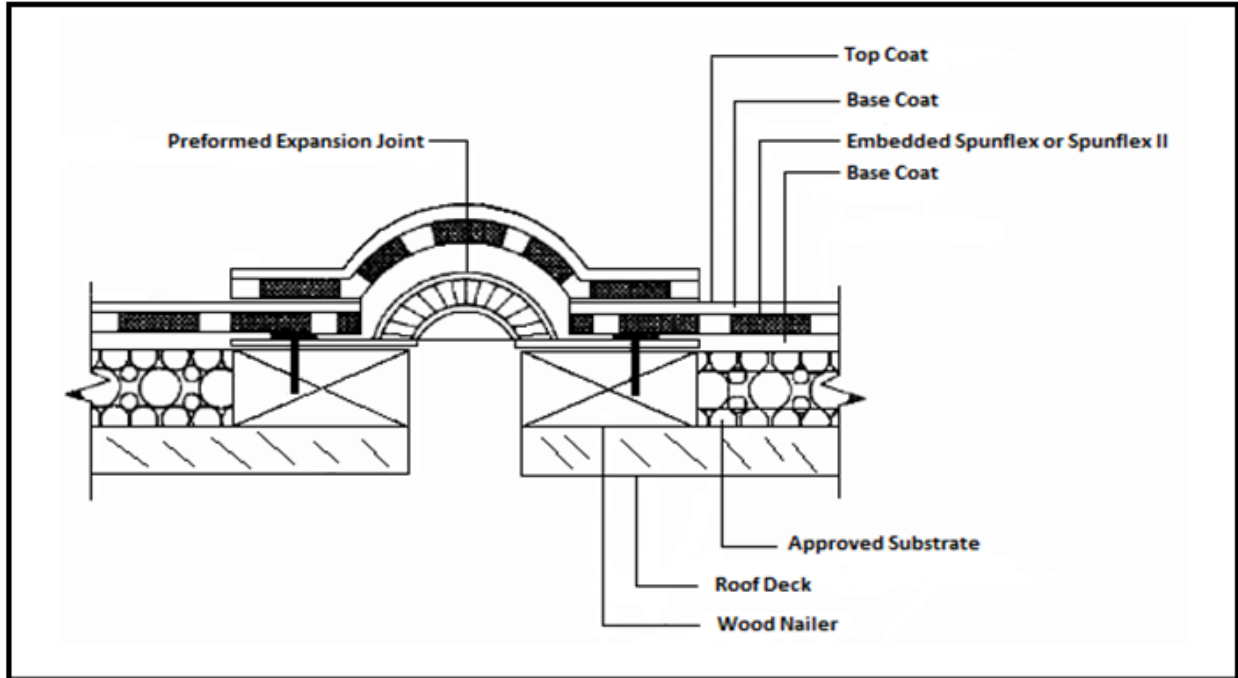

	Fabric Reinforced Expansion Joint		ISSUE / REVISION Date: 2/23/2017	Detail Number. EJ - 23
	Fabric Reinforced System	Acceptable Products Rapid Roof HV Rapid Roof III, Equinox, Benchmark, PUMA XL	NOT TO SCALE	

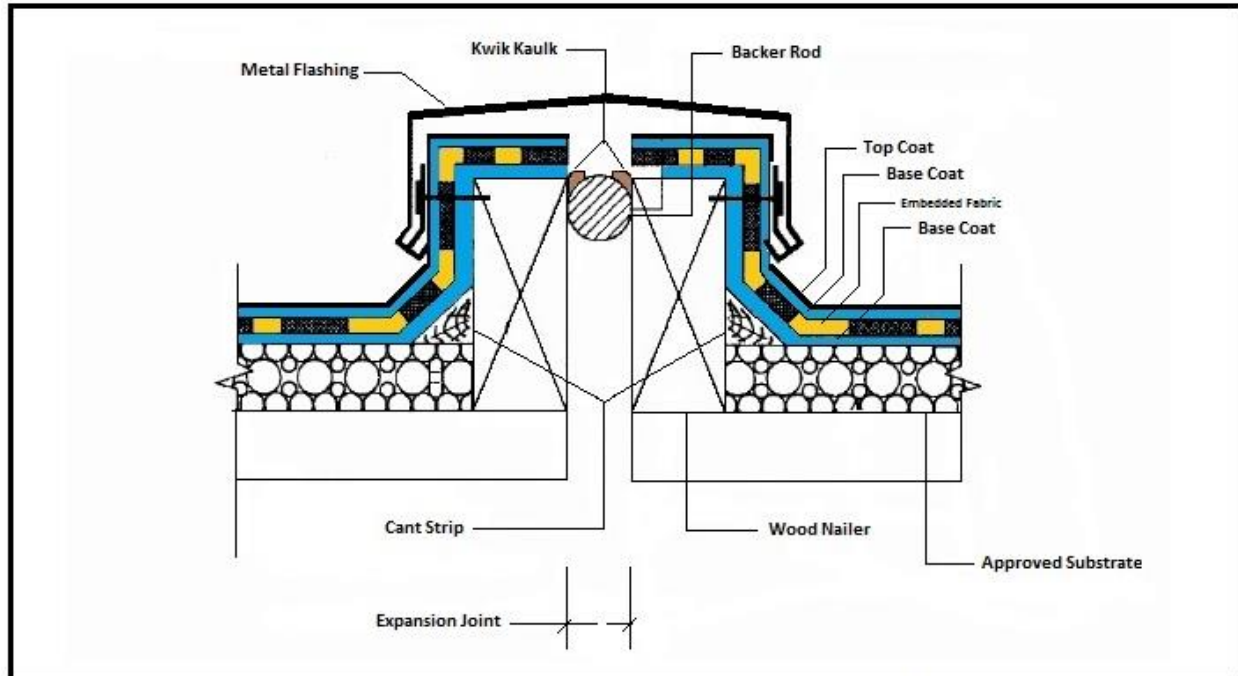

	Fabric Reinforced Expansion Joint		ISSUE / REVISION Date: 2/21/2017	Detail Number. EJ - 1.5
	Fabric Reinforced System	Acceptable Products Rapid Roof HV Rapid Roof III, Equinox, Benchmark, PUMA XL	NOT TO SCALE	

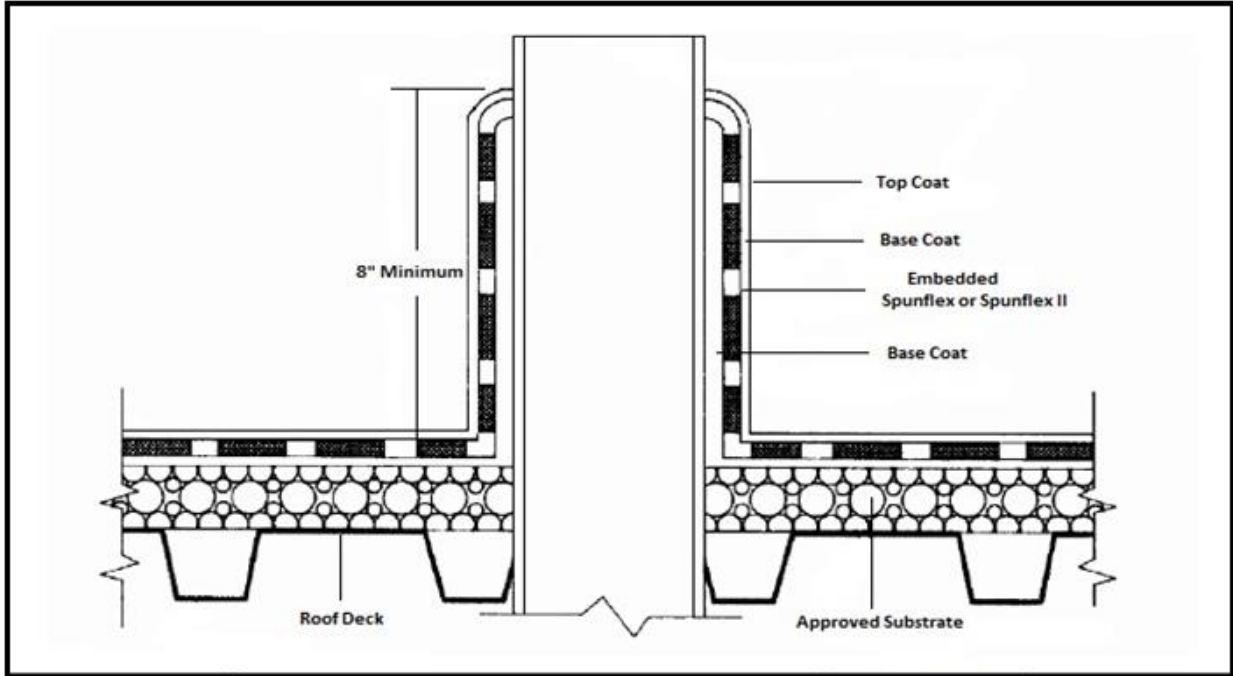

	Fabric Reinforced Pipe Detail		ISSUE / REVISION Date: 2/21/2017	Detail Number. P - 1
	Fabric Reinforced System	Acceptable Products Rapid Roof HV Rapid Roof III, Equinox, Benchmark, PUMA XL	NOT TO SCALE	

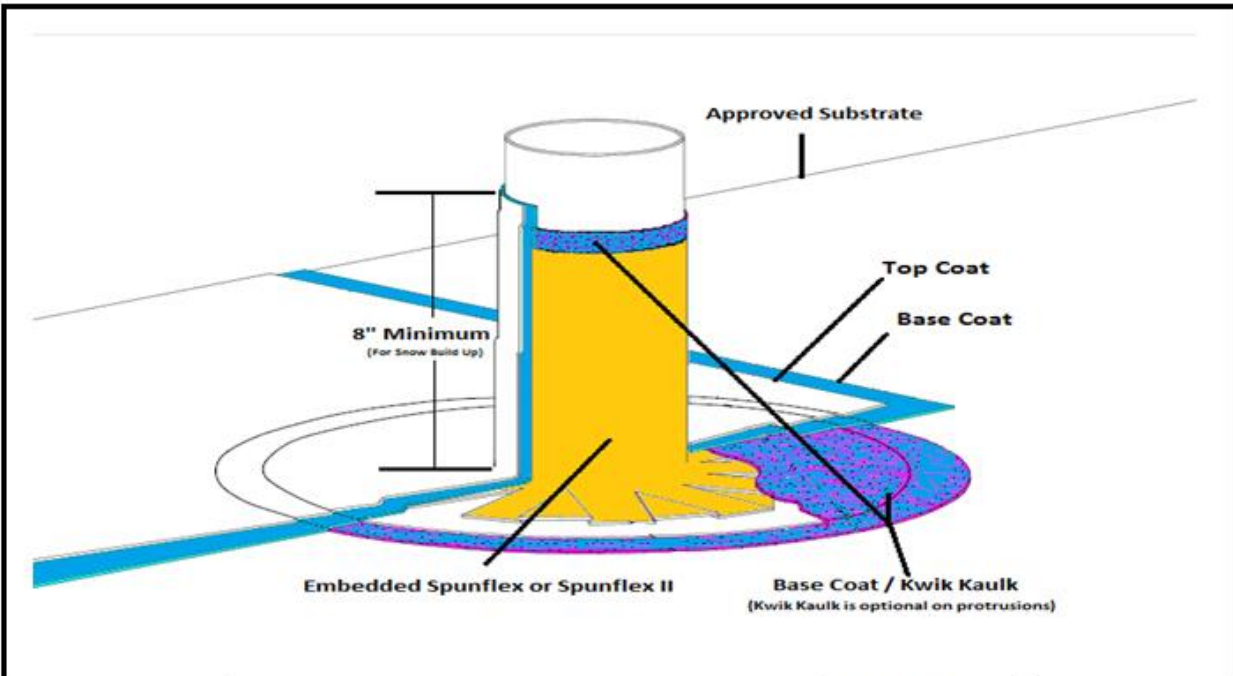

	Fabric Reinforced Pipe Detail		ISSUE / REVISION Date: 2/22/2017	Detail Number. P - 2
	Fabric Reinforced System	Acceptable Products Rapid Roof HV Rapid Roof III, Equinox, Benchmark, PUMA XL	NOT TO SCALE	

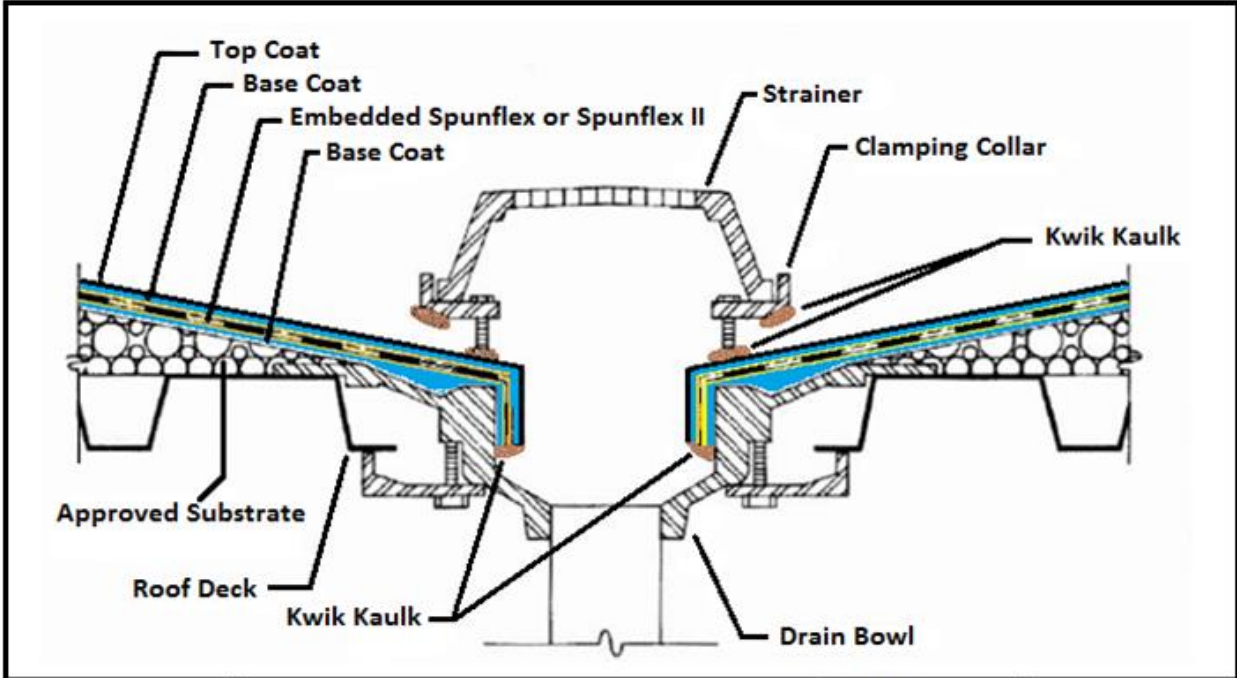

	Fabric Reinforced Drain Detail		ISSUE / REVISION Date: 2/15/2017	Detail Number. DD - 1
	Fabric Reinforced System	Acceptable Products Rapid Roof HV Rapid Roof III, Equinox, Benchmark, PUMA XL	NOT TO SCALE	

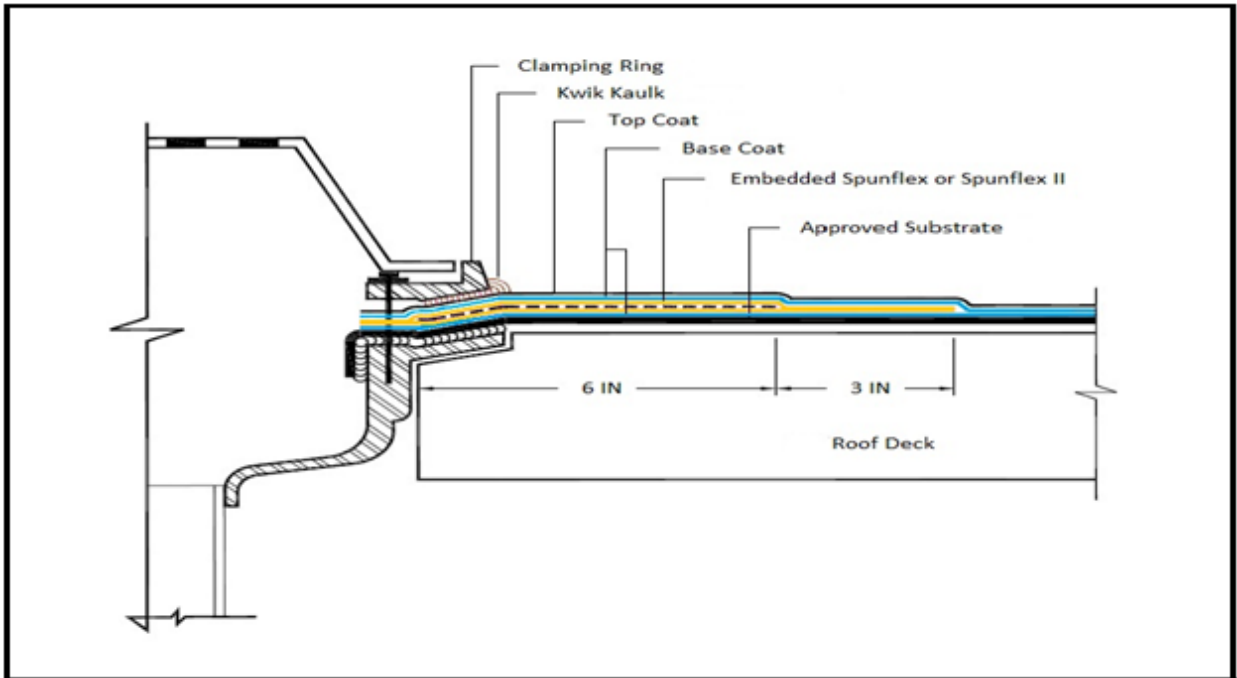

	Fabric Reinforced Drain Detail		ISSUE / REVISION Date: 2/14/2017	Detail Number. DD - 2
	Fabric Reinforced System	Acceptable Products Rapid Roof HV Rapid Roof III, Equinox, Bench mark, PUMA XL	NOT TO SCALE	

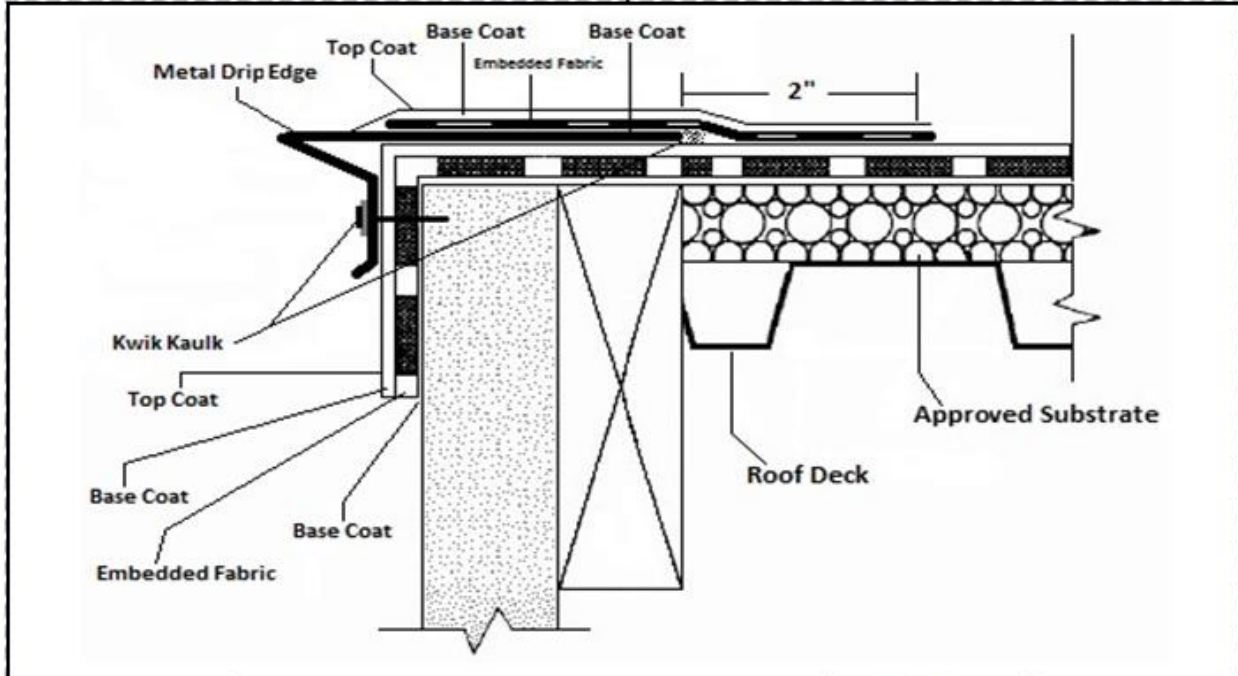

Fabric Reinforced Roof Edge (Metal Drip Edge)

ISSUE / REVISION
Date:

Detail Number.

Fabric Reinforced System

Acceptable Products
Rapid Roof HV Rapid Roof III,
Equinox, Benchmark, PUMA XL

2/23/2017

RE-DE - 4

NOT TO SCALE

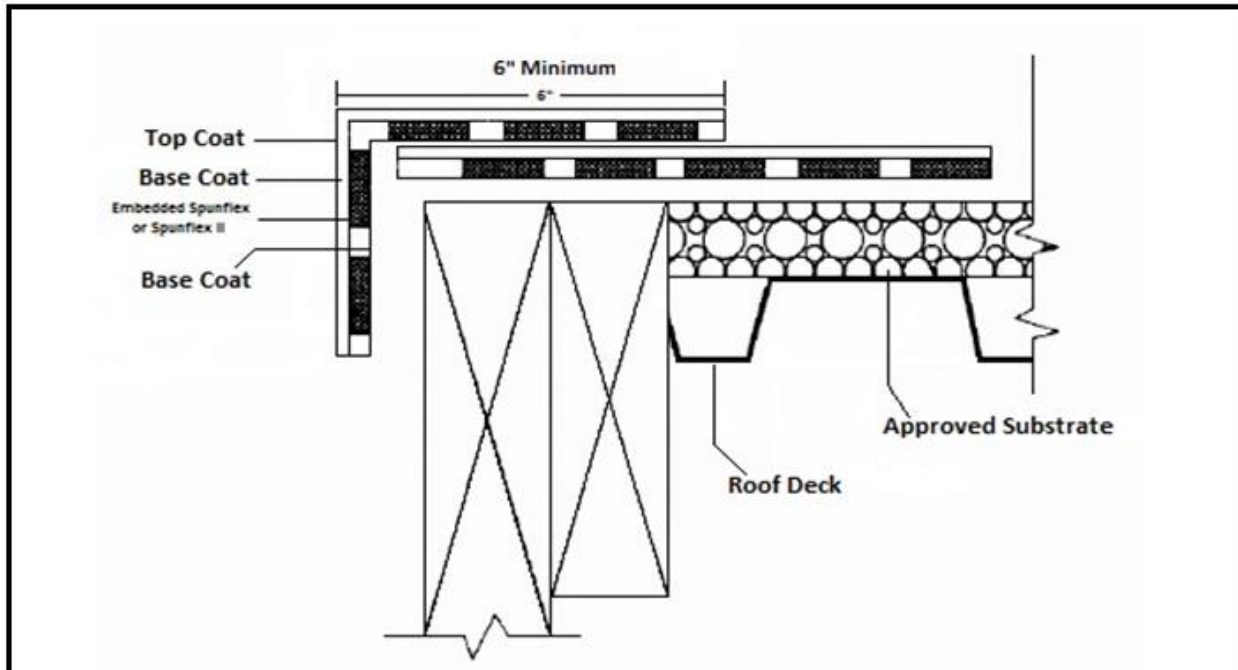

Fabric Reinforced Roof Edge (Wood)

ISSUE / REVISION
Date:

Detail Number.

Fabric Reinforced System

Acceptable Products
Rapid Roof HV Rapid Roof III,
Equinox, Benchmark, PUMA XL

2/22/2017

RE-WD - 4

NOT TO SCALE